

# TABLE TENNIS

INSTALLATION LOOSE-LAID TABLE TENNIS VENUE

gerflor.com



Sport area must be clean and sweep - Ambient temperature min 15°C. Air humidity must not exceed 65%.  
The installation is the same whatever the size of the court to be loose-laid.  
Only the quantities of the rolls, their length, and their positioning can change.

**Gerflor**<sup>®</sup>  
theflooringgroup

INSURING A SUITABLE INSTALLATION.....	p.3
LAYING THE ROLLS OUT FLAT, PLACING AND FIXING THE ROLLS .....	p.4
HOW TO USE THE DOUBLESIDE TAPE ROLLER.....	p.5
TAKE-UP AND REMOVAL OF THE COURT COVERING.....	p.6
CLEANING INSTRUCTIONS.....	p.8

## WARNING ABOUT SUBFLOOR:

- It should be clean, dry and smooth.
- For international competitions, it is recommended to install a suspended wooden subfloor under the Gerflor flooring for table tennis use to offer more comfort, performance and protection for athletes (A3 minimum according to EN 14904).
- A test of the Gerflor double sided onto the wooden subbase shall be done between the LOC, Gerflor representative and the arena owner to verify that the adhesive properties of the tapes will match with the subfloor and won't damage the subfloor.
- Gerflor wishes to receive a written responsibility clearance statement of the arena owner to use Gerflor double sides tapes to avoid any claim by the removal of the floor after the event in case of any damage on the subfloor.

## WARNING ABOUT VENUE'S CONDITIONS:

- Ventilation and air conditions inside the arena : Gerflor request to get a moderate temperature at all times between 15 to 18 degrees. Air humidity must not exceed 65%.
- Ventilations systems can be also used to control the temperature.

## WARNING ABOUT IMPLEMENTATION :

- The implementation of the Table Tennis installation in the venue must be defined by the Organizing Committee.

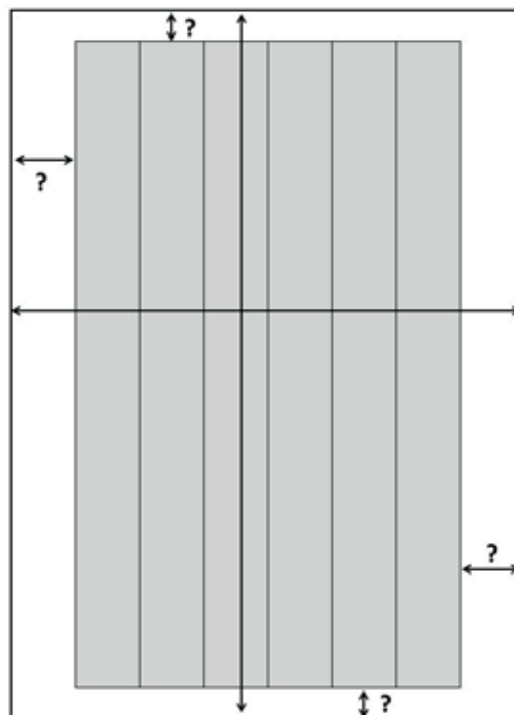

# LAYING THE ROLLS OUT FLAT, PLACING AND FIXING THE ROLLS

Having taken delivery of the rolls:

- Place the rolls upright,
- Carefully remove the wrapping.

**Keep whatever wrapping paper, cardboard, or roll cores which will be needed again when the court is taken up and packed away.**

## MARKING THE LONGITUDINAL GUIDELINE:

Strike a guide line to define longitudinal axis according to Organizing Committee's expectation.

Mark the center 0 of the installation on the longitudinal axis according to Organizing Committee's expectation.

## LAYING THE ROLLS OUT FLAT:

The ambient temperature must be above 15 °C.

The rolls must be ALLOWED TO LAY FLAT in the sports hall for at least 24 hours leaving a gap of 1 cm between each others.

It will let time to the material to relax and to be in the best way to be installed.

## PLACING THE ROLLS:

After 24h of relax time, the rolls are butted up to the axis and placed edge-to-edge without leaving a gap.

Place the center of the length of the rolls according to center 0.

## FIXING THE ROLLS:

The lengths are held together with double-sided adhesive tape from GERFLOR according to subfloor.

Double side tape adhesive is applied under each roll and extremities.

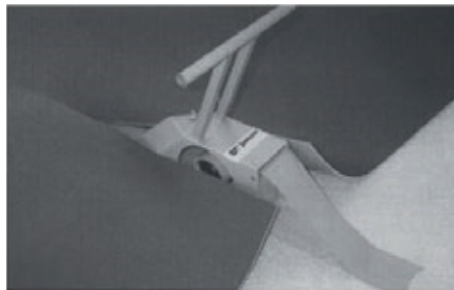
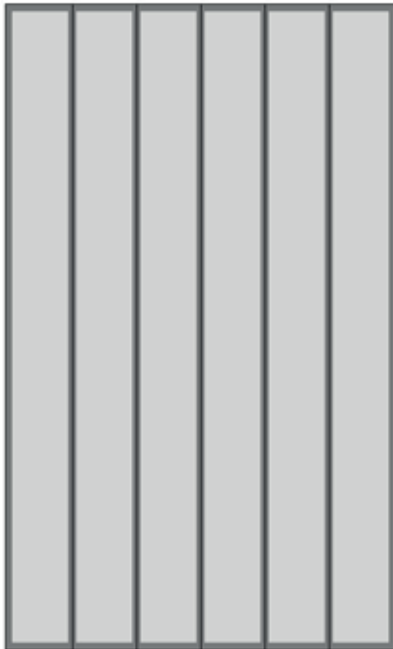

The double-sided adhesive tape is applied with a double side tape roller.  
Ref. H372 0001 from Gerflor.

**NOTE:** If it is being put down on a varnished wood strip flooring, check the adhesion properties before installing. If the subfloor shows advertising logos or stuck-down game lines, they may be damaged.

## IMPORTANT:

GERFLOR cannot be liable for the performance of a double-sided adhesive tape which was not supplied by GERFLOR.

# HOW TO USE THE DOUBLESIDE TAPE ROLLER

Need 2 persons to use the tape roller:

- 1 person to drive the tape machine between the rolls and apply the adhesive.
- 1 person to keep the protector adhesive.

Depending on the nature of the subfloor, these are held in place with GERFLOR'S double sided tapes applied to the underside of all the selvage's by means of a double sided tape dispenser:

- A specific tape needs to be used when overlaying polished parquet or an existing sports floor (smooth subfloors)
- Another specific tape needs to be used when overlaying chipboard and other subfloors (raw subfloors)

Please communicate about your subfloor to the event or technical Gerflor team.

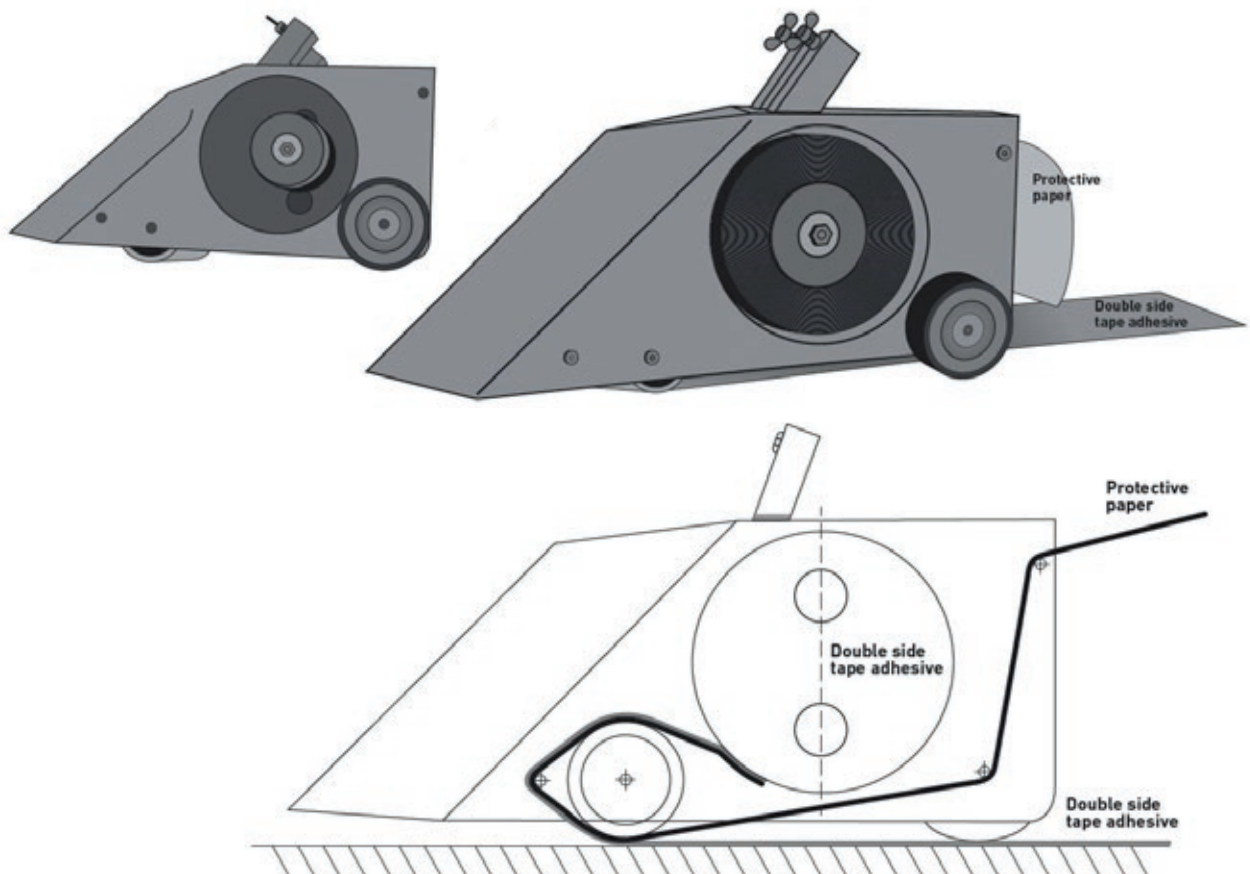
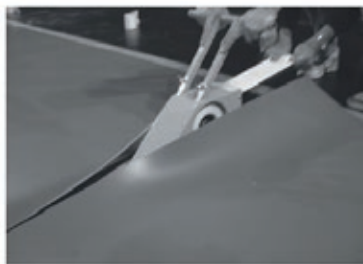
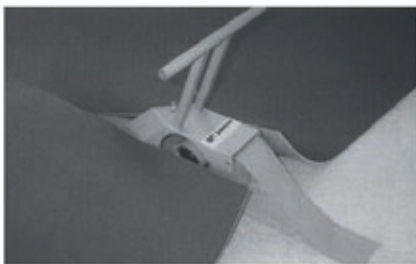

IT IS MOST IMPORTANT THAT PRIOR TO USE YOU CHECK ON THE INSIDE OF EACH DOUBLE SIDED TAPE ROLL THAT IT IS COMPATIBLE WITH THE SURFACE ON WHICH THE COURT IS BEING LOOSE-LAID.

# TAKE-UP AND REMOVAL OF THE COURT COVERING

- Take-up and removal of the court covering must be done after full cleaning.
- Cleaned court surface must be dry when removed.
- Reverse the rolls on themselves to make possible rolling with foam inside.
- Remove the double side tape.

## CORRECT WAY TO ROLL UP THE SHEETS:

### ROLL THE MATERIAL:

- Take up the sheets.
- Fix the material onto cardboard core with AT7 black tapes at each extremity and in the middle of the roll- The foam must be inside (roll was reversed before).
- Secure the sheets with AT7 tape (black tape) – at least two bands per sheet – ensuring they completely encompass the roll

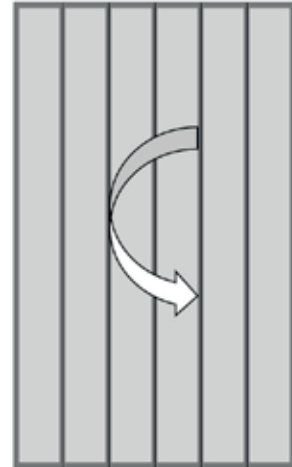

### PROTECT THE ROLL:

- Replace the paper wrapping onto the roll. Fix the paper wrapping with at least two bands of AT7 tape (black tape).
- Clearly indicate on each roll wrapping paper, the roll length and width (example: 16 m x 1.50 m) and roll number reference if there is.

### STORE THE ROLL:

- Store the roll vertically or on suitable storing devices.

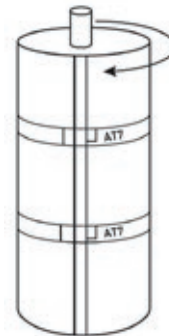

## PUTTING ROLLS ON METAL PALLETS WHEN AVAILABLE:

Put the rolls in the pallets and following this method:

### STRAP 1 AND 3:

Pass the straps in the buckles which are on the tubes

### STRAP 2:

Pass the straps only in the buckles which are on the **back of the pallet** and tight it around the rolls.

This method secure the rolls during the transportation in the truck.

**Attach MUST be between the rolls or with a wrapping paper or watever between the roll and the buckle.**

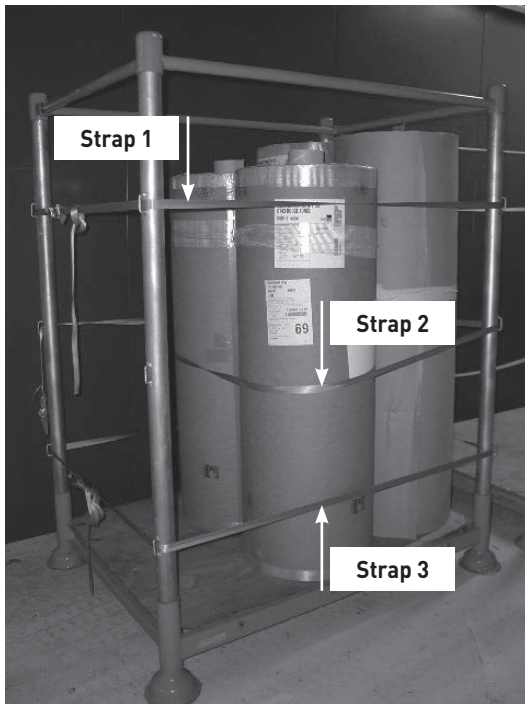

Size metal pallets:  
118 x 155 x 185 cm



## TYPES AND CLEANING FREQUENCY

- A **full cleaning** of the floor must be done **after installation**.
- A **current cleaning** of the floor must be done at least **once a day after the last match**.
- The **full cleaning** before removing the floor must be done **after its last use**.

## NECESSARY EQUIPMENT

- Dry sweeping equipment.
- Spray.
- Cleaning product TRACIFLEX or TANEX TROPHY (alkaline detergent)
- Walk-behind scrubber-dryer using a red pad (3M pad is recommended).



**NB :** It is very important that the suction is effective. The floor should be dry almost immediately. The use of a new suction squeegee is recommended. The walk-behind scrubber-dryer must be used in the sense of the rolls avoiding to go over the roll joints. In this way, you will avoid having water into the joints and unstick the double-sided tape.

## DURING CHAMPIONSHIP – CURRENT CLEANING

During the day if need and after the last match of the day, use the dry sweeping equipment to dry the floor and to remove dust.

## BEFORE AND AFTER CHAMPIONSHIP – FULL CLEANING



- Use the dry sweeping equipment to dry the floor and to remove dust.
- Dilute cleaning product to 5% in the spray.  
  - >> 5% dilution : 5 cL of cleaning product with 95 cL of water
- Spray the diluted cleaning product. Wait 5 min for cleaning product action.
- Fulfill the walk-behind scrubber-dryer with water only and install the red pad
- Clean the floor with the walk-behind scrubber-dryer avoiding going over the roll joints. Water consumption and speed have to be the lowest.
- Let it dry.

**GERFLOR INTERNATIONAL**

Tel: +33 (0)4 74 05 40 00

Fax: +33 (0)4 74 05 03 13

e-mail: gerflorcontract@gerflor.com

gerflor.com / follow us :   

RC Lyon B 726 580 152 - jpe - 03/2026

**WE CARE | WE ACT.** Our commitments for a sustainable future



**CARBON FOOTPRINT\***

-20 % kg CO<sub>2</sub> equivalent/m<sup>2</sup> between 2020 and 2025



**BIOSOURCED CONTENT\*\***

10 % by 2025



**RECYCLED CONTENT**

30 % by 2025



**ADHESIVE FREE\*\*\***

35 % by 2025



**ANNUAL VOLUME RECYCLED**

60,000 t by 2025

\* Scopes 1 & 2 defined in the GHG protocol \*\* % of activity with biosourced materials \*\*\* % of activity with adhesive free solutions

